



UST Systems: Inspecting And Maintaining Sumps And Spill Buckets

Practical Help And Checklist



Contents

Introduction	1
Who Should Read This Manual?	1
How Will This Manual Help You?	1
Why Should You Care About Sump Maintenance?	1
Safety Considerations	3
Getting To Know Your Sumps	4
What Is A Sump?.....	4
What Kinds Of Sumps Are Associated With My UST System And Where Are They Located?	4
How Do You Access Your Sumps And Spill Buckets?	6
Basic Maintenance Procedures For Sumps And Spill Buckets.....	7
What Can You Do To Ensure Your Sumps and Spill Buckets Are In Good Condition?	7
What Should You Look For When You Inspect Your Turbine, Dispenser, And Transition/Intermediate Sumps?	7
What Should You Look For When You Inspect Your Spill Buckets?	12
Where Can You Get More Information On This Topic?	15

Appendix A: Sample Underground Storage Tank Sump And Spill Bucket Inspection Checklist

This document provides information on inspecting and maintaining sumps and spill buckets. The information provided in this manual is not intended to replace or contradict your specific manufacturer's instructions for maintaining your sumps. Nothing in this manual is intended to endorse or criticize any specific type of equipment or any manufacturer. Photographs of common sump problems are provided for instructional purposes only. This document does not replace existing federal or state regulations, nor is it a regulation itself - it does not impose legally binding requirements. For regulatory requirements regarding UST systems, refer to the federal regulations governing underground storage tank systems (40 CFR Part 280) or corresponding state regulations.

Additional copies of this manual are available at no cost by calling EPA's toll-free distribution center at 800-490-9198. Or you can download a color copy by going to OUST's World Wide Web Home Page at <http://www.epa.gov/oust/pubs>

Introduction

Who Should Read This Manual?

This manual is intended for owners and operators of underground storage tank (UST) systems; specifically, anyone who oversees the operation and maintenance of UST systems that contain and dispense petroleum products. UST owners/operators should ensure that only qualified personnel conduct inspection and maintenance activities.

How Will This Manual Help You?

This manual covers recommended inspection guidelines and best management practices for sumps associated with your UST system. This manual will:

- ❖ Help you identify and inspect the sumps associated with your UST system, including the equipment in your sumps.
- ❖ Explain some simple steps you can take to maintain your sumps and the equipment in your sumps, as well as identify potential problems.
- ❖ Provide you with tips for fixing common problems before they cause a release to the environment.

For more complete guidance on how to operate and maintain your UST system, refer to the U.S. Environmental Protection Agency (EPA) document, *Operating And Maintaining Underground Storage Tank Systems, Practical Help And Checklists (EPA 510-B-05-002, May 2005)*.

Why Should You Care About Sump Maintenance?

Despite advances that have greatly reduced the threat of petroleum releases from UST systems into the environment, some UST systems continue to experience releases. Inadequate operation and maintenance is one reason these systems continue to experience releases.

After reading this manual, you should be able to identify the different types of sumps associated with your UST system and be familiar with how to identify some common sump-related problems.

The average cleanup cost for a leaking UST is about \$100,000. The cost can be more than \$1,000,000 if groundwater is affected.

UST Systems: Inspecting And Maintaining Sumps And Spill Buckets

Sumps, including the sumps beneath dispensers, sumps around the submersible pump (turbine) head¹, transition/intermediate sumps, and spill buckets are common sources of releases. Releases of even small volumes of product can seep into the ground and contaminate soil and groundwater. Inspecting and maintaining your sumps is generally simple and can prevent or minimize such releases.

While this manual addresses a number of issues related to sump maintenance, it may not cover some details specific to your particular sumps. Keep in mind the information provided in this manual is not intended to replace or contradict your specific manufacturer's instructions for maintaining your sumps and the equipment in your sumps.

This manual presents practical help and a checklist for inspecting and maintaining sumps. State and local agencies may require these or other activities. Please check with your state or local agency to determine their specific requirements.

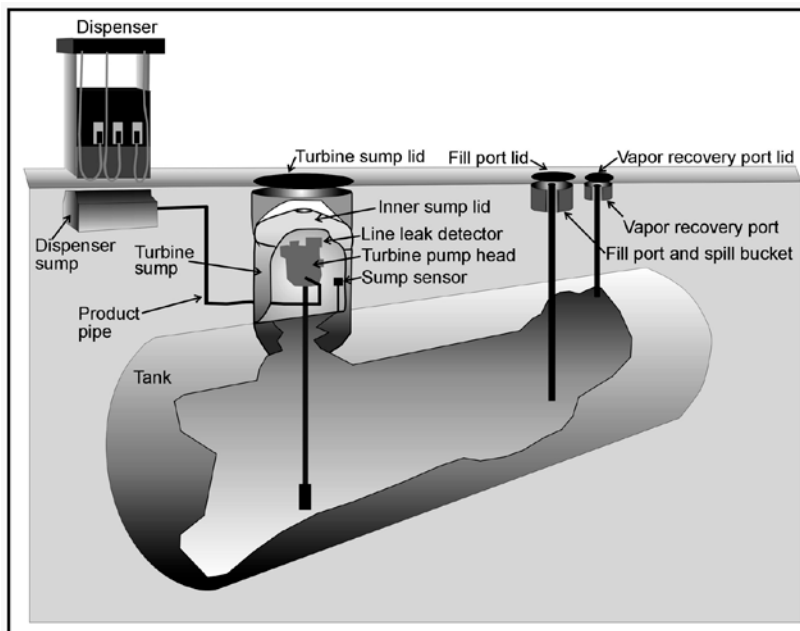

Diagram of an UST system

¹ Submersible turbine pumps are often known by their acronym STP.

Safety Considerations

If you perform sump inspection and maintenance activities, you should be experienced and aware of hazards and safety issues. Chances are you will be working in a high-traffic area, such as a gas station. You should properly mark off your work area and take appropriate steps to protect yourself. You should have the following items:

- ❖ Safety barriers, such as traffic cones or yellow plastic tape to mark off your work area
- ❖ Orange safety vest
- ❖ Hard hat (for construction sites)
- ❖ Steel-toed boots
- ❖ First-aid kit
- ❖ Chemical resistant gloves

You should consider these additional safety precautions:

- ❖ Sump lids may be large and very heavy and may require more than one person to lift. Use caution when lifting large steel lids.
- ❖ Be aware of the possibility of explosive or harmful vapors when inspecting and maintaining sumps. Avoid breathing in petroleum vapors.
- ❖ Please note that OSHA designates some sumps as confined spaces. See OSHA's standard on confined spaces in Title 29 of the *Code of Federal Regulations*, Part 1910.146.
http://www.osha.gov/pls/oshaweb/owadisp.show_document?p_table=STANDARDS&p_id=9797



Person wearing safety gear while inspecting a sump



Person removing a sump lid within a marked inspection area

Getting To Know Your Sumps

What Is A Sump?

A sump is a subsurface area (pit) designed to provide access to equipment located below ground and, when contained, to prevent liquids from releasing into the environment.

Sumps may or may not be contained. Contained sumps have sides and a bottom, are designed to be liquid tight, and may have a special cover designed to keep out water. Uncontained sumps generally do not have a bottom and are not designed to prevent liquid from entering or exiting the sump. These sumps may use wooden or metal sheeting to restrict the slumping of soil or crushed rock onto the equipment and to prevent the surface pavement from buckling or caving.

What Kinds Of Sumps Are Associated With My UST System And Where Are They Located?

The types of sumps likely to be associated with your UST system are:

Turbine Sumps – Turbine sumps are designed to provide access to the turbine area above the tank. The turbine area may house the submersible turbine pump head, piping, line leak detectors, interstitial monitoring devices, wiring, and other equipment. You generally will find turbine sumps directly above your USTs. Turbine sump lids generally range from 3 to 4 feet in diameter and can be round, oval, square, or rectangular in shape.

Dispenser Sumps – Dispenser sumps are designed to provide access to piping, flex connectors, shear valves, and other equipment located beneath the dispenser. Dispenser sumps are found directly under your dispensers.



Uncontained turbine sump



Contained turbine sump



Contained dispenser sump

UST Systems: Inspecting And Maintaining Sumps And Spill Buckets

Transition/Intermediate Sumps – Transition/intermediate sumps are less common than other sumps, but can be found along the piping runs that connect the tanks to the dispensers, and are designed to provide access to the piping. Transition sumps are used to transition from above-ground piping to below-ground piping or, in some cases, to transition between different types of piping. Intermediate sumps are located at key points in the piping system (e.g., low spots, branches, tees). Transition/intermediate sump lids generally range from 3 to 4 feet in diameter and can be round, oval, square, or rectangular in shape.

Spill Buckets – Spill buckets are contained sumps installed at the fill and/or vapor recovery connection points to contain drips and spills of fuel that can occur during delivery. Spill buckets are located where the delivery driver connects the product and/or vapor recovery hoses to your tank. Spill buckets can be found directly above your UST, at a location that is away from your UST (remote), or both. They typically range in size from 5 to 25 gallons, and lids range from 1 to 2 feet in diameter. Spill buckets may also be installed within a larger sump, similar in construction to a turbine sump, for secondary containment. In this case, you will only need to open your smaller lids to access your spill buckets.



Transition/intermediate sump



Spill bucket



Fill and vapor recovery lids installed within a larger sump lid

Spill Bucket Lid

Turbine Sump Lid



View of sump lids

Did You Know?
Most UST systems must have spill buckets at each fill pipe where fuel is delivered into the UST. Some facilities also may have a second spill bucket around the Stage I vapor recovery line.

How Do You Access Your Sumps And Spill Buckets?

You may need tools such as a large screwdriver, pry bar, wrench, or hammer to open your sump lids. Composite lids may require a specialized tool that you probably have on site. Have someone help you in lifting large lids, as they may be very heavy. Use caution when opening the lids and be aware of the following:

- ❖ Square, rectangular, or oval sump lids can fall through the opening and damage the piping, submersible pump, or tank.
- ❖ Round lids, while not typically capable of falling into the sump, may swing down and damage the turbine head or line leak detector.
- ❖ If applicable, follow your equipment manufacturer's recommendations if special instructions are necessary to open the sump lids.
- ❖ You may need a key to remove the dispenser cover in order to access the dispenser sumps.

Generally, sumps will have a traffic load rated lid, beneath which may be either direct access to the equipment or, if contained, an inner lid covering the contained area.



Circular steel sump lid pulled back to show the inner lid covering the turbine sump



Square steel sump lid pulled up to show the inside of an uncontained turbine sump



Circular spill bucket lid pulled back to show the fill port with a spill bucket



Dispenser cover pulled off to show the dispenser piping and equipment

Basic Maintenance Procedures For Sumps And Spill Buckets

What Can You Do To Ensure Your Sumps and Spill Buckets Are In Good Condition?

Maintaining your sumps and spill buckets will involve gaining access to them, inspecting them on a regular basis, assessing whether any problems exist, and ensuring any problems are addressed. For serious problems (e.g., obvious leaks occurring on the piping and equipment, cracked spill buckets or sidewalls, cracked or missing seal around the lid), it's best to contact your UST contractor or the manufacturer of your UST equipment to have the problem fixed. Appendix A contains a sample checklist you may want to use to guide your sump inspections.

What Should You Look For When You Inspect Your Turbine, Dispenser, And Transition/Intermediate Sumps?

Are The Lids Tight And Sealed Correctly? Check to ensure the lids to the turbine, transition, and intermediate sumps create a tight seal when closed and are securely fastened. The seals of the sump lids often dry out, crack, and require replacement; so you need to ensure they are in good condition. Water in your sumps may be an indication of a bad seal.

Are The Sump Walls Intact? Check to ensure the walls of your sump are intact and are not slumping or warping. If your sump is not contained, check the sidewalls to ensure there is no caving.

Note: To avoid accumulation of surface water, you should check the seals of your sumps' lids more frequently if they are located at a low point on the property or in the path of surface water runoff.

If you identify or suspect a release of fuel to the environment, report this to your implementing agency. For a list of state UST websites, go to: <http://www.epa.gov/oust/states/statcon1.htm>

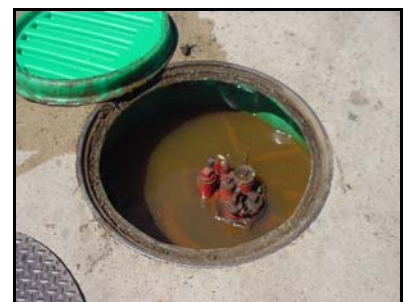

Contained turbine sump full of liquid

UST Systems: Inspecting And Maintaining Sumps And Spill Buckets

Is The Sump Free Of Debris, Liquid, Or Ice? Debris, liquid, and ice can damage equipment, reduce capacity (if contained), and interfere with your equipment's ability to operate correctly. For example, water in your sump will reduce capacity and may cause metal equipment in your sump to corrode. Fuel in your sump will also reduce capacity and may damage some plastic sumps and other components not designed for long term contact with petroleum. Similarly, used dispenser filters may contain small amounts of petroleum, so they should not be left inside your sump. You should carefully remove and properly dispose of any debris, liquid, or ice in your sumps.

Did You Know?
Some sensors may alarm only when in contact with petroleum. If covered completely with water, they will not alarm, even in the event of a petroleum leak.



Dry, debris-free contained turbine sump



Contained sump with liquid and debris

Is The Sump Free Of Cracks Or Holes? Examine your contained sumps for signs of damage (e.g., cracks or holes). Check to ensure no cracks are present around the areas where components, such as wiring conduit and piping, enter your sumps. Cracks and holes mean your sump will no longer contain product or prevent releases to the environment.

Are Sump Components Leak-Free? Check to ensure the piping, fittings, and connections in your sump are not leaking or dripping fuel.

Is The Sump Free Of Staining/New Staining? Check to ensure no new stains are present since your last inspection. New staining indicates a drip or spill has occurred.



Staining

UST Systems: Inspecting And Maintaining Sumps And Spill Buckets

Are The Sensors Positioned Correctly?² If you have sensors, check to ensure they are positioned properly in the lowest part of your sump and below the piping entry. Sensors should not be raised as the result of false alarms or for any other reason. Raised or disabled sensors will take longer or fail to detect a leak and could violate regulatory requirements.

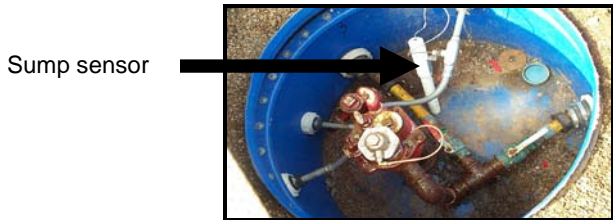

Sump sensor in contained turbine sump



Float sump sensor



Liquid sump sensor

Are All Penetrations Into The Sump In Good Condition?²

Check to ensure all areas where electrical wires, conduits, and piping enter the sump are sealed. Cracked or loose seals around the penetrations can allow liquids to enter the sump and can allow fuel to be released into the surrounding soils if a release occurs inside the sump.



Sump penetration seals in poor condition



Sump penetration seals in good condition

Did You Know?
A crack or hole in your sump below the sump sensor will not allow liquid to accumulate in the sump to a level necessary to activate the sensor. As a result, liquid may be released undetected. Such cracks or holes need to be repaired immediately.

Did You Know?
Some plastic flexible piping is installed within a larger pipe (or chase). There may be a seal between the primary pipe and the chase. Check with the piping maker to determine the proper position of the seal.

² Only for contained sumps

UST Systems: Inspecting And Maintaining Sumps And Spill Buckets

Are The Test Boots Positioned Correctly And In Good Condition?³ A test boot is found on secondarily-contained piping and is a flexible sleeve usually made of rubber with a valve located either at the entry to the sump or on the piping in the sump. It is used to test the space between the inner and outer piping walls for tightness. Check to ensure the test boots are in good condition, not cracked or torn, and positioned correctly in the sump.

To ensure a leak can be detected by your leak detection equipment, test boots should be positioned so they allow product to enter your sump if a leak from the primary piping occurs. There are a variety of different configurations for test boots. If you are unsure of the appropriate configuration, check with your contractor.



Test boot located in a sump



Test boots positioned at sump wall, right test boot is torn

Is The Piping And Other Equipment In Good Condition?

Sumps may contain various types of piping and equipment such as leak detection equipment, turbine motors, line leak detectors, sensors, conduits, and flex connectors.



Contained turbine sumps and equipment in good condition

Did You Know?
If your metal piping, including metal flex connectors, is in contact with the ground, it must be protected from corrosion.

³ Typically only for contained sumps

UST Systems: Inspecting And Maintaining Sumps And Spill Buckets

When inspecting the piping and equipment in your sumps, you should watch for the following conditions:

- ❖ For metal piping, check to ensure the piping is not severely corroded, in contact with the ground if it does not have corrosion protection, or otherwise degraded.
- ❖ For fiberglass piping, check to ensure the piping is not cracked, delaminated, or otherwise degraded.
- ❖ For flexible piping, check to ensure the piping does not have abnormal bends, breaks, cracks, or kinks; is not bulging, swelling, or growing; has not become soft, spongy, or discolored; and is not otherwise distorted or degraded.
- ❖ Check to ensure the fittings and flexible connectors are not twisted or misaligned and the flexible connectors are not cracked, kinked, etc.
- ❖ Check to ensure other pieces of equipment, including pump head, line leak detector, and sensors, are not visibly damaged, severely corroded, etc.



Equipment and metal piping covered with dirt in uncontained sump



Fiberglass piping is cracked

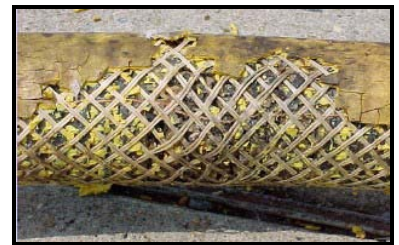

Flexible piping is degraded due to microbial growth



Flexible piping is cracked

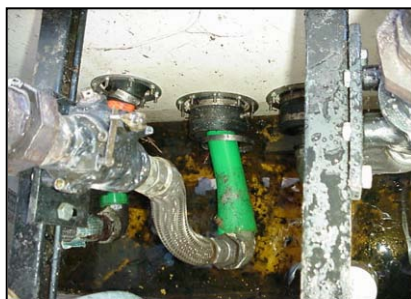

Metal flexible connector is twisted due to growth of flexible plastic piping



Flexible piping is kinked



Flexible piping is bulging

What Should You Look For When You Inspect Your Spill Buckets?

Are The Lids To Your Spill Buckets In Good Condition? Check to ensure the lids to your spill buckets are in good condition so they will keep water out when the lid is closed. Ensure that when the lids to your spill buckets are in the closed position, they create a good seal and are secured tightly. Some spill buckets contain a rubber gasket inside the cover; check to ensure the rubber gasket is in good condition and creates a proper seal when the lid is closed.



Cracked spill bucket lid



Spill bucket lid gasket

A missing or damaged spill bucket lid may be a safety hazard. Replace it as soon as possible. Until the lid is replaced, cover and barricade the area to prevent potential accidents.

Check to ensure the lid is not touching the fill cap. This situation should be repaired because it could potentially damage the fill pipe and the tank if it is in an area where vehicles drive over the lid.

Is The Spill Bucket Free Of Debris, Liquid, Or Ice? Examine your spill buckets to determine whether they contain debris, liquid, or ice. For example, water in your spill bucket will reduce capacity and may cause metal equipment in your sump to corrode. Fuel in your spill bucket will also reduce capacity and may damage some plastic spill buckets not designed for long term contact with petroleum. You should carefully remove and properly dispose of any debris, liquid, or ice found in your spill buckets during your inspections. You should also check for and remove any liquid and debris present in your spill buckets before and after every delivery.



Spill bucket that contains liquid

UST Systems: Inspecting And Maintaining Sumps And Spill Buckets

Some spill buckets are equipped with a valve that allows you to drain accumulated liquid into your UST. Others may be equipped with a manual pump so fuel can be transferred to your UST system by pumping it through the fill pipe or removing the fuel and disposing of it properly. However, keep in mind that when you pump out or drain your spill bucket into your UST, any water and debris present also will enter the UST. This could lead to internal corrosion, dispensing problems, and the need to remove contaminated water from the tank. If your spill bucket is not equipped with a drain valve or pump, you can still remove the liquid and debris and dispose of them appropriately. Liquid can be removed with a portable pump, such as the one on the right.



Portable pump

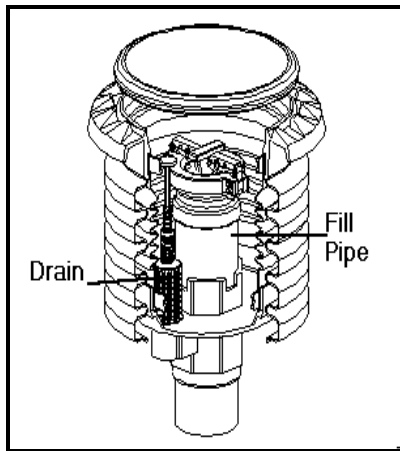

Spill bucket with a drain valve

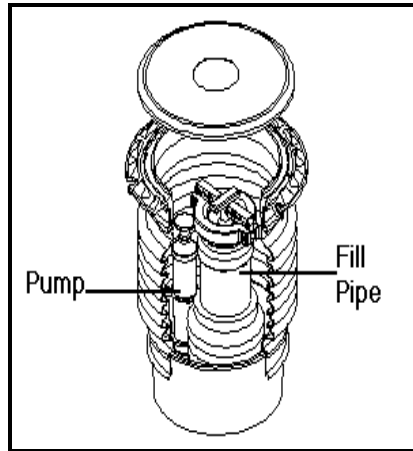

Spill bucket with a manual pump

If your spill bucket is always dry, this may be an indication that it is not able to contain product. You may need to test to ensure it is liquid tight.

Is The Spill Bucket Free Of Cracks Or Holes? Examine the spill buckets for evidence of cracks or holes. If you have a metal bucket, check for corrosion and rust. Also check for deformations in the spill buckets or separation of the spill bucket from the fill pipe.



Spill bucket in poor condition – note the gap between the spill bucket and the fill pipe

Are The Drain Valves Operational? Some spill buckets have drain valves. Check to ensure the drain valve is free of debris and operational (e.g., it can close tightly and be opened to drain fuel in the spill bucket). If the drain valve is left open:

- ❖ It will act as a vent
 - Possibly affecting the ability of your overfill device to function properly;
 - Allowing potentially dangerous vapors to build up in the spill bucket or to be released to the soil or groundwater;
 - Possibly affecting the operation of the Stage II vapor recovery system.
- ❖ It can allow water and debris to enter your tank.



Spill bucket drain valve

Never pump fuel from your spill buckets into storm or sewer drains as a method of disposal. Improper disposal can contaminate surface and groundwater, result in vapor/explosion hazards, damage sewage treatment plants, and may be in violation of state or federal law.

Where Can You Get More Information On This Topic?

Federal Agencies

U.S. EPA
Office of Underground Storage Tanks
<http://www.epa.gov/oust>

U.S. Department of Labor
Occupational Safety and Health Administration
<http://www.osha.gov>
1-800-321-OSHA (6742)

Organizations

API - American Petroleum Institute
www.api.org
(202) 682-8000

FTPI - Fiberglass Tank and Pipe Institute
www.fiberglasstankandpipe.com
(281) 568-4100

NACE International - Formerly National Association of
Corrosion Engineers
www.nace.org
(281) 228-6200

NFPA - National Fire Protection Association
www.nfpa.org
(617) 770-3000

PEI - Petroleum Equipment Institute
www.pei.org
(918) 494-9696

STI - Steel Tank Institute
www.steeltank.com
(847) 438-8265

Publications

The publications listed below are free and available from the U.S. EPA. You can access these publications via EPA's website or you can call, write to, or fax EPA.

- ❖ You can download, read, or order documents from <http://www.epa.gov/oust/pubs/index.htm>
- ❖ To order free copies or ask questions, call EPA's publication distribution toll-free number at 800-490-9198 or fax 301-604-3408. You can also write and ask for free publications by addressing your request to EPA's publication distributor: National Service Center for Environmental Publications (NSCEP), Box 42419, Cincinnati, OH 45242.

Operating and Maintaining Underground Storage Tank Systems: Practical Help and Checklists, U.S. EPA, Office of Underground Storage Tanks, Washington DC, EPA 510-B-05-002, May 2005.

Musts for USTs: A Summary of the New Regulations for Underground Storage Tank Systems, U.S. EPA, Solid Waste and Emergency Response, Washington DC, EPA-510-K-95-002, July 1995.

Model Underground Storage Tank Environmental Results Program Workbook, U.S. EPA, Solid Waste and Emergency Response, Washington DC, EPA R-04-003, June 2004.

Other Sources

For additional information on UST system operation and maintenance, go to U.S. EPA Office of Underground Storage Tanks, List of Operation and Maintenance Tools
<http://www.epa.gov/oust/ustsystem/tanko&m.htm>

For links to state UST websites go to
<http://www.epa.gov/oust/states/statcon1.htm>

Appendix A

Note: Federal UST regulations do not require you to report your maintenance activities, use this form, or keep any specific records of your sump inspection and maintenance practices.

Sample Underground Storage Tank Sump And Spill Bucket Inspection Checklist

Name: _____ Date/Time Of Inspection: _____

Comments/Follow-Up Needed: _____

Choose yes or no for each question that applies.
 Choosing no on any item indicates a problem that should be corrected.
 When you have corrected the problem, check the fixed box.

Turbine/Transition/Intermediate Sumps	Sump No.: _____			Sump No.: _____			Sump No.: _____			Sump No.: _____		
	Yes	No	Fixed?	Yes	No	Fixed?	Yes	No	Fixed?	Yes	No	Fixed?
Are The Lids Tight And Sealed Correctly?			<input type="checkbox"/>			<input type="checkbox"/>			<input type="checkbox"/>			<input type="checkbox"/>
Are The Sump Walls Intact?			<input type="checkbox"/>			<input type="checkbox"/>			<input type="checkbox"/>			<input type="checkbox"/>
Is The Sump Free Of Debris, Liquid, Or Ice?			<input type="checkbox"/>			<input type="checkbox"/>			<input type="checkbox"/>			<input type="checkbox"/>
Is The Sump Free Of Cracks Or Holes?*			<input type="checkbox"/>			<input type="checkbox"/>			<input type="checkbox"/>			<input type="checkbox"/>
Are Sump Components Leak-Free (No Leak Or Drips)?			<input type="checkbox"/>			<input type="checkbox"/>			<input type="checkbox"/>			<input type="checkbox"/>
Is The Sump Free Of Staining/New Staining?			<input type="checkbox"/>			<input type="checkbox"/>			<input type="checkbox"/>			<input type="checkbox"/>
Are The Sensors Positioned Correctly?*			<input type="checkbox"/>			<input type="checkbox"/>			<input type="checkbox"/>			<input type="checkbox"/>
Are All Penetrations Into The Sump In Good Condition?*			<input type="checkbox"/>			<input type="checkbox"/>			<input type="checkbox"/>			<input type="checkbox"/>
Are The Test Boots Positioned Correctly And In Good Condition?*			<input type="checkbox"/>			<input type="checkbox"/>			<input type="checkbox"/>			<input type="checkbox"/>
Is The Piping And Other Equipment In Good Condition?			<input type="checkbox"/>			<input type="checkbox"/>			<input type="checkbox"/>			<input type="checkbox"/>
Dispenser Sumps	Dispenser No.: _____			Dispenser No.: _____			Dispense No.: _____			Dispenser No.: _____		
	Yes	No	Fixed?	Yes	No	Fixed?	Yes	No	Fixed?	Yes	No	Fixed?
Is The Sump Free Of Debris, Liquid, Or Ice In The Sump?			<input type="checkbox"/>			<input type="checkbox"/>			<input type="checkbox"/>			<input type="checkbox"/>
Is The Sump Free Of Cracks Or Holes?			<input type="checkbox"/>			<input type="checkbox"/>			<input type="checkbox"/>			<input type="checkbox"/>
Are Sump Components Leak-Free (No Leak Or Drips)?			<input type="checkbox"/>			<input type="checkbox"/>			<input type="checkbox"/>			<input type="checkbox"/>
Is The Sump Free Of Staining/New Staining?			<input type="checkbox"/>			<input type="checkbox"/>			<input type="checkbox"/>			<input type="checkbox"/>
Are The Sensors Positioned Correctly?			<input type="checkbox"/>			<input type="checkbox"/>			<input type="checkbox"/>			<input type="checkbox"/>
Are All Penetrations Into The Sump In Good Condition?			<input type="checkbox"/>			<input type="checkbox"/>			<input type="checkbox"/>			<input type="checkbox"/>
Are The Test Boots Positioned Correctly And In Good Condition?			<input type="checkbox"/>			<input type="checkbox"/>			<input type="checkbox"/>			<input type="checkbox"/>
Is The Piping And Other Equipment In Good Condition?			<input type="checkbox"/>			<input type="checkbox"/>			<input type="checkbox"/>			<input type="checkbox"/>
Spill Buckets	Bucket No.: _____			Bucket No.: _____			Bucket No.: _____			Bucket No.: _____		
	Yes	No	Fixed?	Yes	No	Fixed?	Yes	No	Fixed?	Yes	No	Fixed?
Are The Lids To Your Spill Buckets In Good Condition?			<input type="checkbox"/>			<input type="checkbox"/>			<input type="checkbox"/>			<input type="checkbox"/>
Is The Spill Bucket Free Of Debris, Liquid, Or Ice?			<input type="checkbox"/>			<input type="checkbox"/>			<input type="checkbox"/>			<input type="checkbox"/>
Is The Spill Bucket Free Of Cracks Or Holes?			<input type="checkbox"/>			<input type="checkbox"/>			<input type="checkbox"/>			<input type="checkbox"/>
Are The Drain Valves Operational?			<input type="checkbox"/>			<input type="checkbox"/>			<input type="checkbox"/>			<input type="checkbox"/>

*Only for contained sumps

